

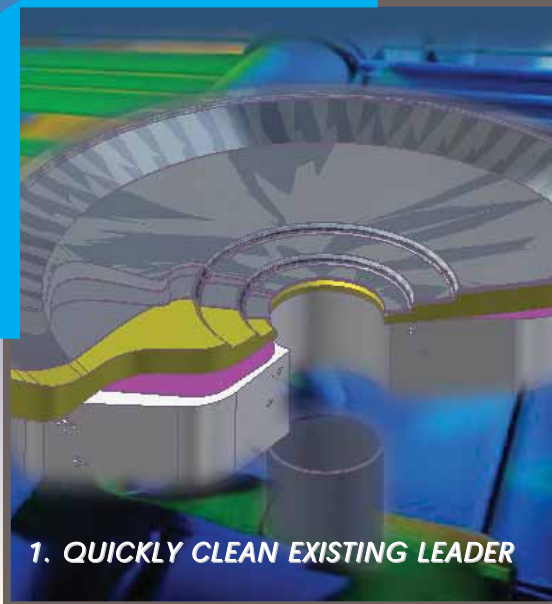

SUPER-SEAL RETROFIT DRAIN SEAL (EPDM OUTLET-TO-LEADER GASKET)



The Most Cost Efficient, Installer-Friendly, Versatile and Maintenance Free Retrofit Drain Product On The Market To-Day



SUPER-SEAL RETROFIT DRAIN SEAL

BACKGROUND

Rain accumulating on roofs employ roof drains to remove the water. The system works well until drains or pipes become clogged due to debris entering the system, missing strainers, vandalism, or similar causes. When a blockage occurs, water will rise back up to the top of the drainage pipe at roof level. The seal between the drain outlet and drainage pipe now becomes critical. Without an adequate seal, water will penetrate the juncture of the drain outlet and rainwater leader and enter the building, causing severe damage.

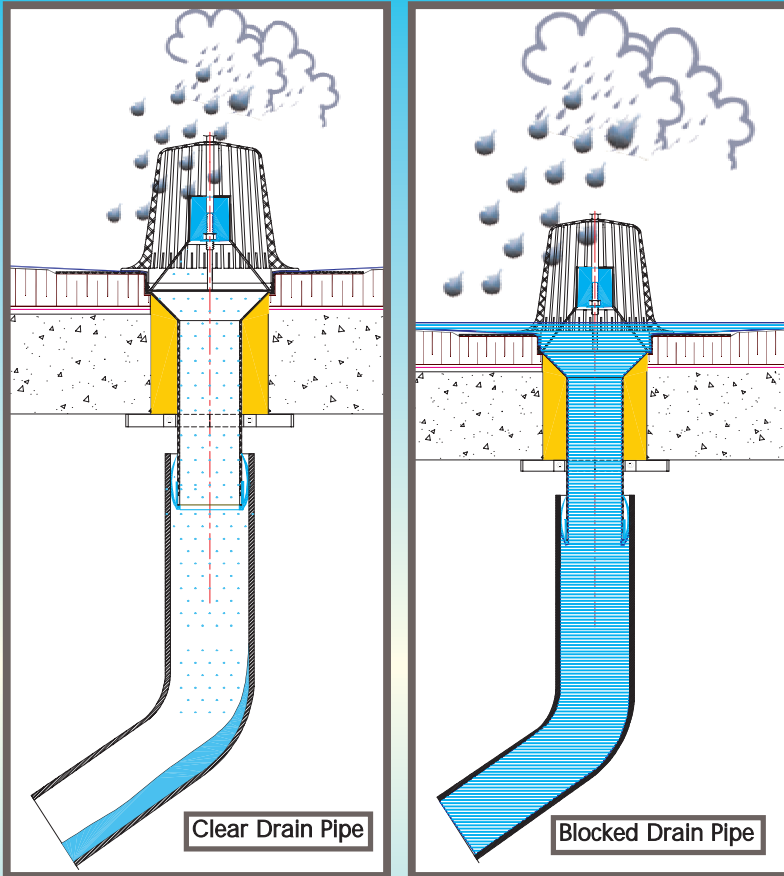

With the costly repair of leaking plumbing and potential for damage to the building interior and contents, quality and durability should be prime considerations in drain design.

Thaler Super-Seal

The Thaler Super-Seal is a patented, injection molded elastomer sealing ring manufactured using EPDM (Ethylene Propylene Diene Monomer). This "ring gasket", supplied snug to fit to the end of any Thaler roof drain outlet, is made slightly larger than the leader inside diameter. When the drain outlet (with Super-Seal) is squeezed into the leader, the EPDM attempts to return to its original size due to the "memory" in the EPDM, thereby providing a 100% water tight seal. The EPDM maintains its original shape, even after 20 years, and allows the drain to be re-used time and time again for any subsequent re-roofing.

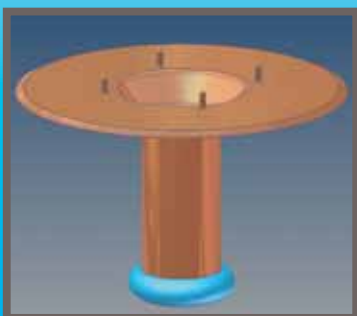

Super-Seal Shown on End Of Drain Outlet

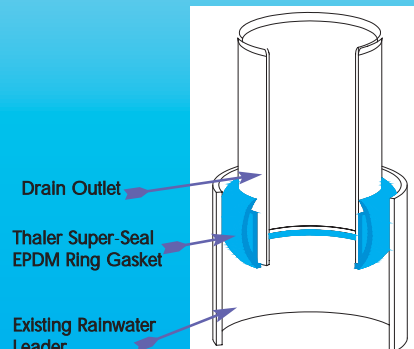

Section Detail at Drain Outlet

Comparison With Major Competitor's Retrofit Drain

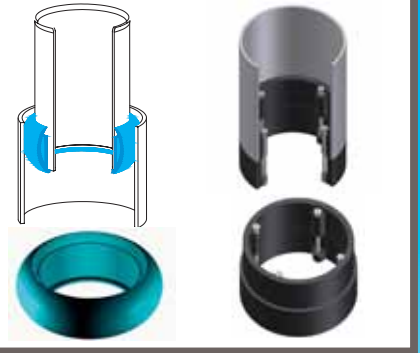

PROPERTY	THALER SUPER-SEAL	COMPETITOR'S SEAL
Function	Seals retrofit drain to existing rainwater leader.	Seals retrofit drain to existing rainwater leader.
Installation Time	2 minutes	Expensive, time consuming installation (up to 1/2 hour)
Sizes	Fits all 2", 3", 4", 5" and 6" (51 mm, 76 mm, 102 mm, 127 mm, 152 mm) Schedule 40 and 80 pipes.	Fits all 3", 4", 5" and 6" (76 mm, 102 mm, 127 mm, 152 mm) Schedule 40 and 80 pipes.
Overall Drain Cost	Cost efficient product	Expensive product (up to 400% more expensive)
Maintenance	Maintenance Free	Once installed, an annual check of the seal is required to ensure that fastening bolts are tight.
Flow Area	Does not reduce the flow area of drain pipe (installed outside pipe)	Reduces the flow area of drain pipe (installed inside the pipe) and foreign material can cling and accumulate, obstructing the flow.
Warranty	20 year warranty	Standard one year warranty

Recommended Use

Suitable for use with PVC, cast iron, steel, copper or other type leaders. Fits all 2", 3", 4", 5" and 6" (51 mm, 76 mm, 102 mm, 127 mm, 152 mm) Schedule 40 and 80 leaders.

Super-Seal is supplied as standard with all Thaler Retrofit Roof Drains. Super-Seal may be specified for use with any Thaler roof drain in lieu of a brass or aluminum ferrule. See back page as well as the Roof Drains section of the Thaler technical manual.

Approvals

All Thaler roof drains employing Super-Seal conform to ANSI A112.21.2 (Roof Drains).

Warranty

20 year warranty against leaks and defects in materials and/or manufacture when installed in accordance with Thaler "Installation Instructions". Copy of Warranty Certificate available upon request.

Maintenance

No maintenance required (maintenance free), however, as per CRCA/NRCA recommendations, drains should be inspected twice a year (spring and fall) or after a storm and any debris removed both around and inside strainer.

Availability

Thaler roof drains employing Super-Seal are available throughout North America. Contact Thaler for list of distributors and current cost information.

Superior Performance is Backed By Hydrostatic Testing and a 20 Year Warranty

TECHNICAL DATA

Hydrostatic Test Results for Super-Seal*

The purpose of the testing was to establish at what pressure water bypassed the installed Super-Seal ring gasket, and to substantiate Thaler claims of superiority over any other competing retrofit roof drain.

Nominal Size Steel Rainwater Leader	Steel "Rainwater Leader" I.D.	Copper "Drain Outlet" Pipe O.D.	** Maximum Applied Pressure at Which Leakage Occurred		
			psi (kPa)	H ₂ O (mm)	psf (kPa)
2" (51 mm)	1.97" (50 mm) Sched 80	1.37" (34.8 mm)	2.67 psi (18.40 kPa)	74" H ₂ O (1880 mm)	384 psf (18.40 kPa)
	2.06" (52.3 mm) Sched 40		1.55 psi (10.69 kPa)	43" H ₂ O (1093 mm)	223 psf (10.63 kPa)
3" (76 mm)	2.92" (74.2 mm) Sched 80	2.35" (59.7 mm)	3.28 psi (22.61 kPa)	91" H ₂ O (2311 mm)	472 psf (22.6 kPa)
	3.070" (78 mm) Sched 40		2.78 psi (19.17 kPa)	77" H ₂ O (1956 mm)	400 psf (19.15 kPa)
4" (102 mm)	3.84" (97.5 mm) Sched 80	3.32" (84.3 mm)	2.75 psi (18.96 kPa)	76.1" H ₂ O (1933 mm)	396 psf (18.96 kPa)
	4.04" (102.6 mm) Sched 40		1.10 psi (7.58 kPa)	30.5" H ₂ O (775 mm)	158 psf (7.57 kPa)
5" (127 mm)	4.875" (124 mm) Sched 80	4.34" (110 mm)	30 psi (206.84 kPa)	830" H ₂ O (21 082 mm)	4320 psf (206.84 kPa)
	5.084" (129 mm) Sched 40		1.84 psi (12.68 kPa)	51" H ₂ O (1295 mm)	265 psf (12.69 kPa)
6" (152 mm)	5.743" (146 mm) Sched 80	5.258" (134 mm)	20 psi (137.89 kPa)	553" H ₂ O (14 046 mm)	2880 psf (137.89 kPa)
	6.050" (154 mm) Sched 40		1.37 psi (9.44 kPa)	38" H ₂ O (965 mm)	197psf (9.44 kPa)

* Test performed by ITS (Intertek Testing Services), Mississauga, Ontario, Canada. A copy of the actual test report is available from Thaler upon request.

** A cubic foot (28.32 L) of water weighs approximately 62.4 lbs (28.3 kg). A one-inch (25 mm) high column of water exerts a pressure of 1/1728 of 62.4 (28.3 kg) or .361 lbs (1.64 kg) on one square inch (645 mm²).

On one square foot (0.0929 m²) the load is 1/12 of 62.4 (28.3 kg) or 5.2 lbs (2.36 kg). Stated another way, the measurement of a static head of 1" (25 mm) water column equals 5.2 psf or 0.036 psi (0.670 kPa or 0.248 kPa) pressure. The conversion factor for 1 inch of water (H₂O) column (20°C, 68°F) is 3 374.110 Pa or 3.374 110 kPa.

GENERAL PROPERTIES OF EPDM (ASTM)

Advantages

Excellent resistance to heat, ozone and sunlight; very good flexibility at low temperatures; good resistance to alkalis, acids and oxygenated solvents; superior resistance to water and steam; excellent colour stability.

Limitations

Poor resistance to oil, gasoline and hydrocarbon solvents.

Physical Properties

Specific Gravity	0.86
Hardness, Durometer	30A - 90A
Tensile Strength	500 - 3500
Elongation %	100 - 700
Compression Set %	20 - 60
Resilience %	40 - 75
Tear Resistance	Fair - Good

Thermal Properties

Service Temperature Max. 121°C (250°F), Min. -54°C (-65°F)

Thermal Value

The Thaler Super-Seal will provide the equivalent thermal resistance as a 1" (25 mm) thick double glazed window.

Specific Resistance

Oxidation	Excellent
Ozone	Excellent
Sunlight Aging	Excellent
Heat Aging	Excellent
Flame	Poor
Oil	Poor
Fuel	Poor
Ketone Esters	Excellent
Allphatic Hydrocarbons	Poor
Aromatic Hydrocarbons	Fair
Weather	Excellent
Water	Very Good

INSTALLATION

"Installation Instructions" are provided with every Thaler roof drain. Essentially, drains equipped with Super-Seal are installed in three easy steps:

1. Prepare and clean existing rainwater leader before installing the new drain equipped with Super-Seal.
2. Using the silicone compound provided in the small pouch affixed to the instructions, apply silicone evenly around the Super-Seal ring.
3. Install drain into existing leader by slowly rotating and pressing into place.. It's that simple; there are no bolts to tighten or tools required.

Notes:

- a. To remove drain for any reason e.g. re-roofing, simply rotate drain slowly pulling upwards. The Super-Seal ring will remain intact for later re-insertion, following steps 1,2 and 3 above.
- b. On roof, drain deck flange is to be flashed in according to the instructions provided with the specific drain type.

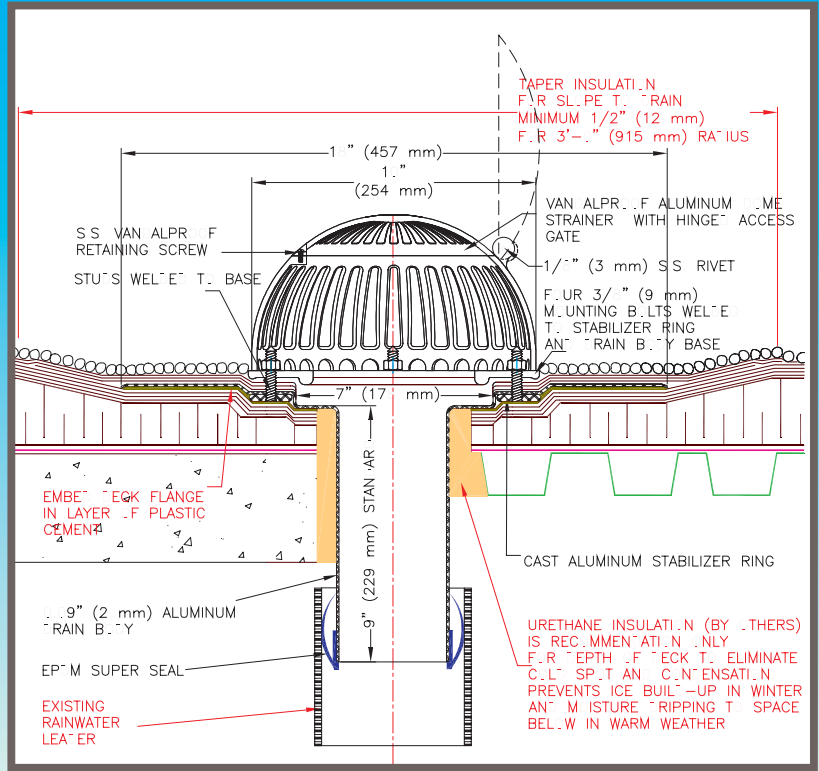

Typical Super Seal Section Detail

THALER DRAIN PRODUCTS AVAILABLE WITH SUPER-SEAL

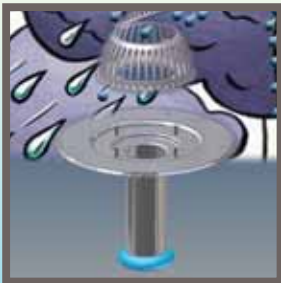

RD-4 RR

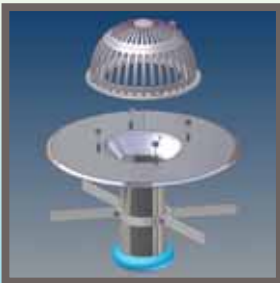

RD-4 RR

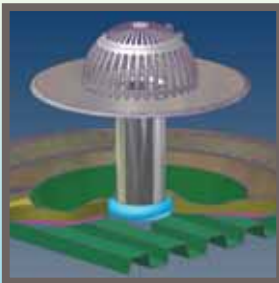

RD-14 RR

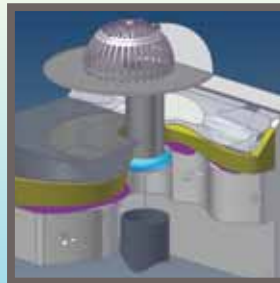

RD-16 RR



RD-160 RR

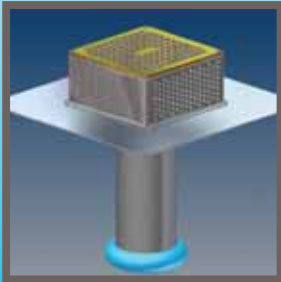

RD-19 RR



RD-24 RR



RD-240 RR



RD-28 RR

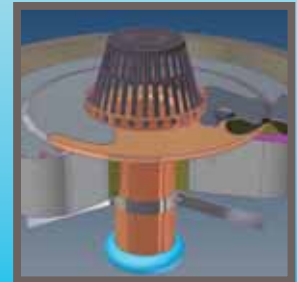

RD-29 RR

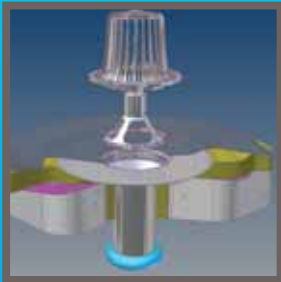

RDX30 RR



RDX300 RR

1902 Common St. Suite 500
 New Braunfels, Texas, 78130, USA
 tel: 830-626-6001 fax: 830-626-6010
 tel: 866-583-6001, 800-576-1200
www.thalermetalusa.com
THALER
 Metal USA Inc. 
THALER
 Metal Industries Ltd.
 2611 Drew Road, Mississauga, ON,
 L4T 1G1, CANADA
 tel: 905-677-1520 fax: 905-677-1503
 1-800-387-7217
www.thalermetal.com



RD-38 RR

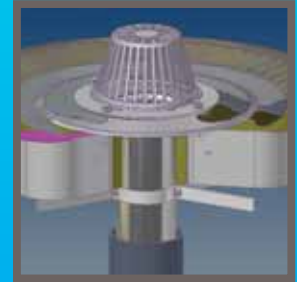

RD-39 RR